

A is a

Name: _____

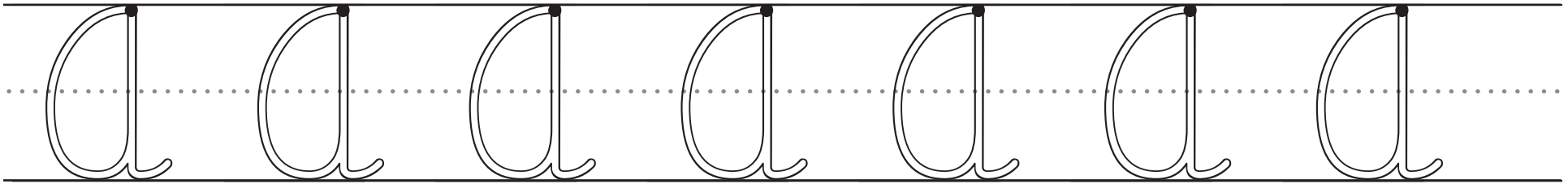
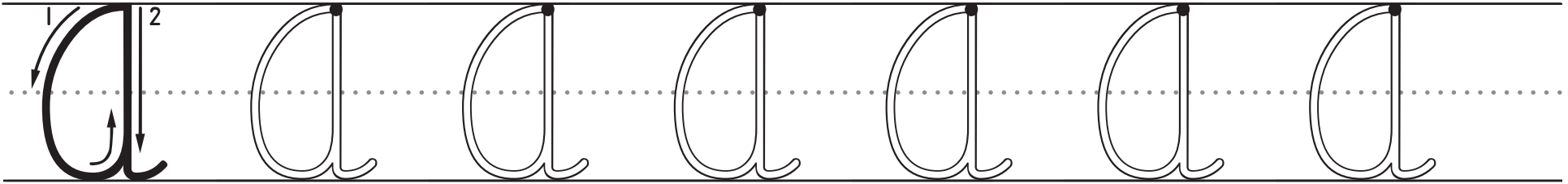

teacher check: _____

cursive A:

B is B

Name: _____

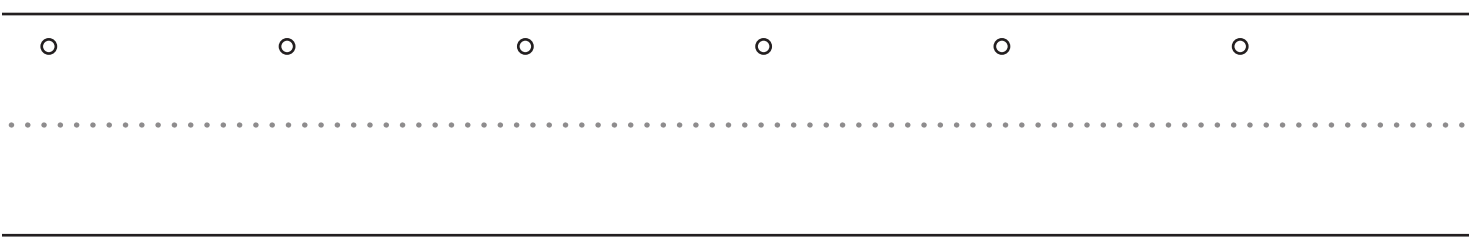
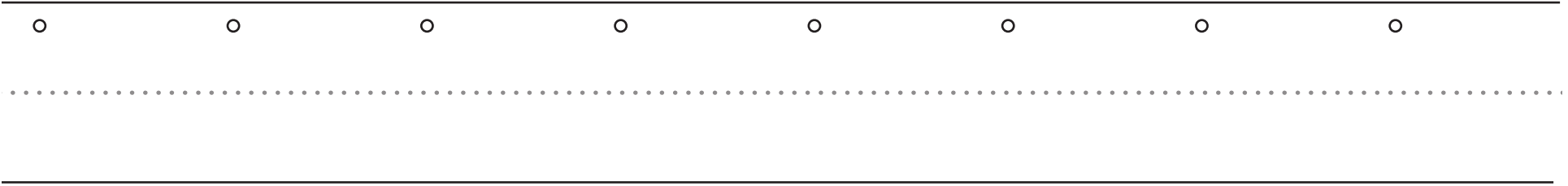
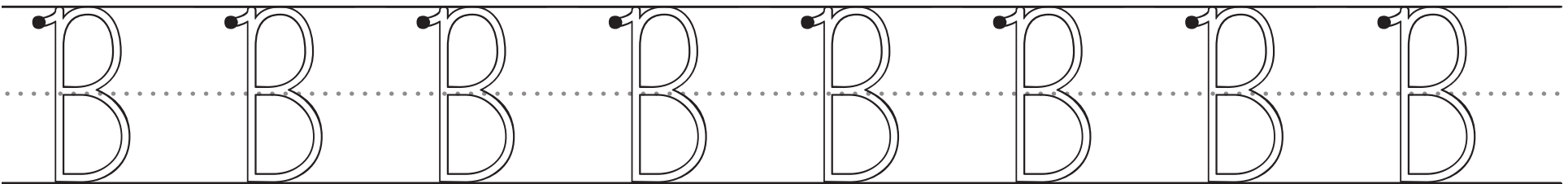
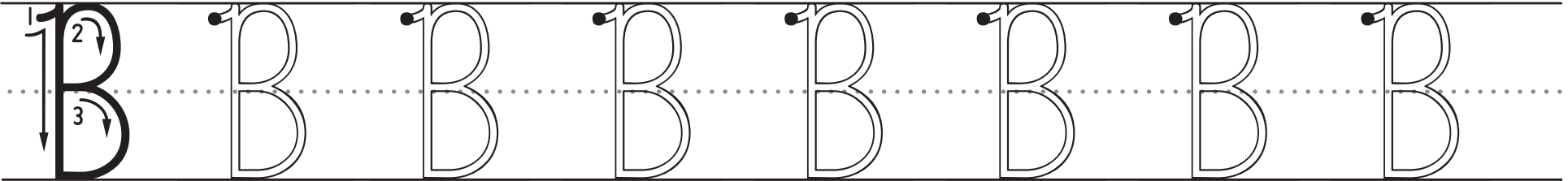

teacher check: _____

cursive B:

C i s C

Name: _____

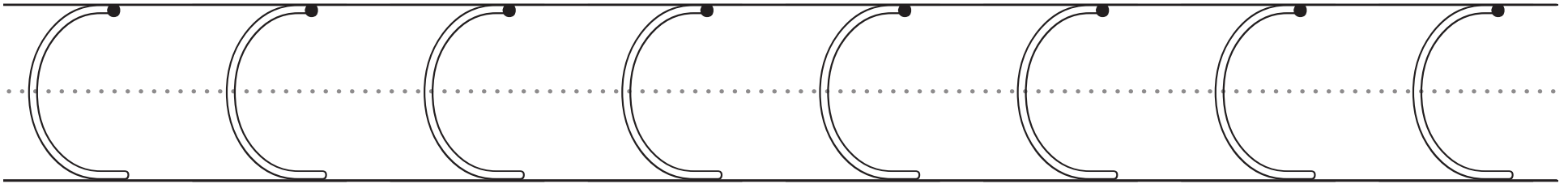
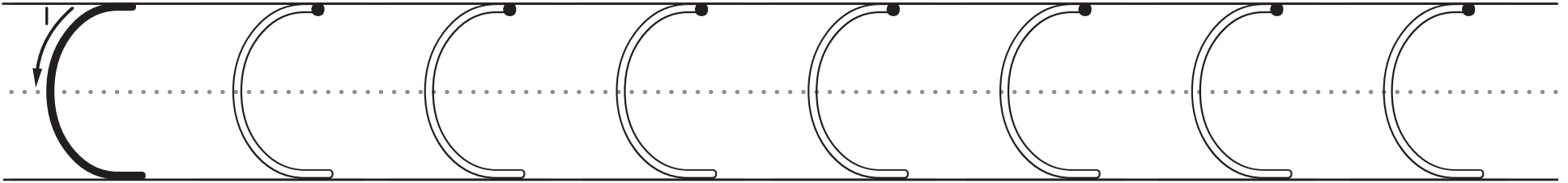

teacher check: _____

cursive C:

D is D

Name: _____

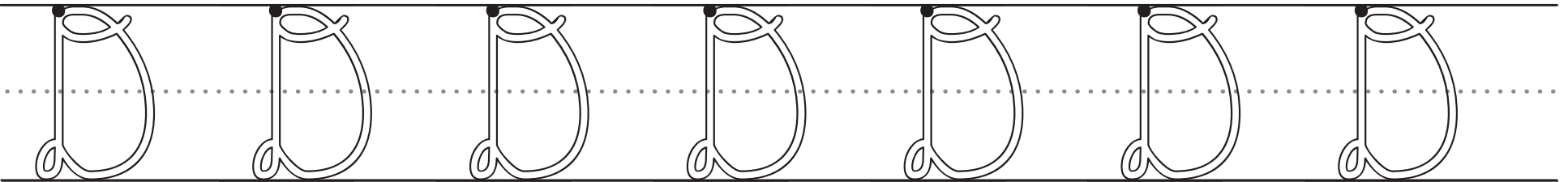
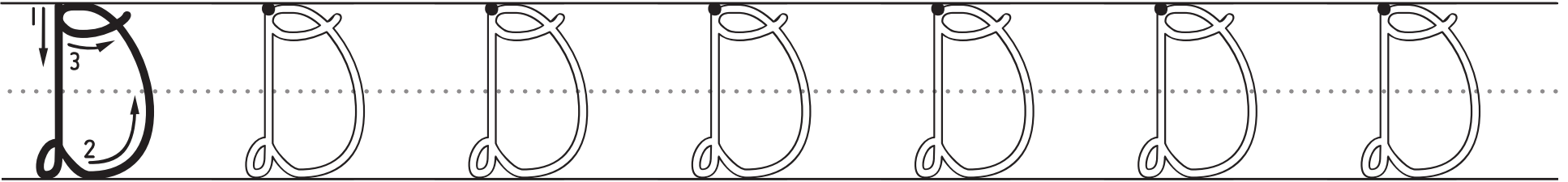

teacher check: _____

cursive D:

E is E

Name: _____

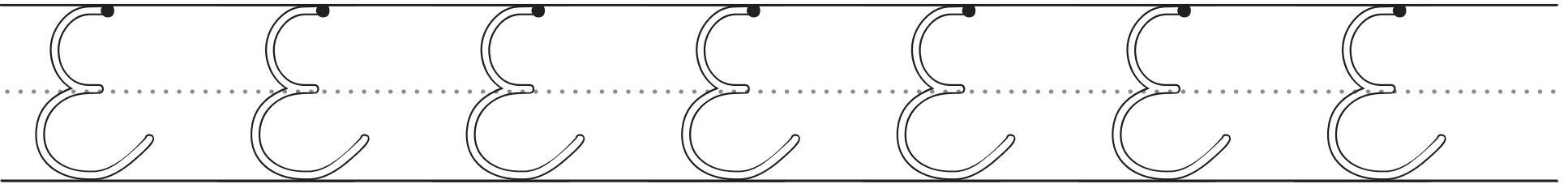
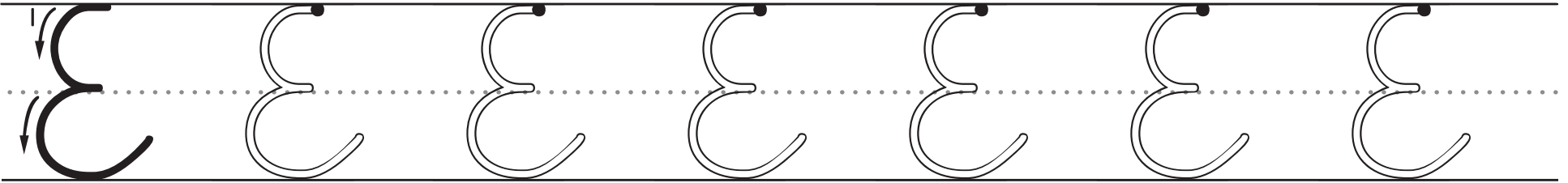

teacher check: _____

cursive E:

F is f

Name: _____

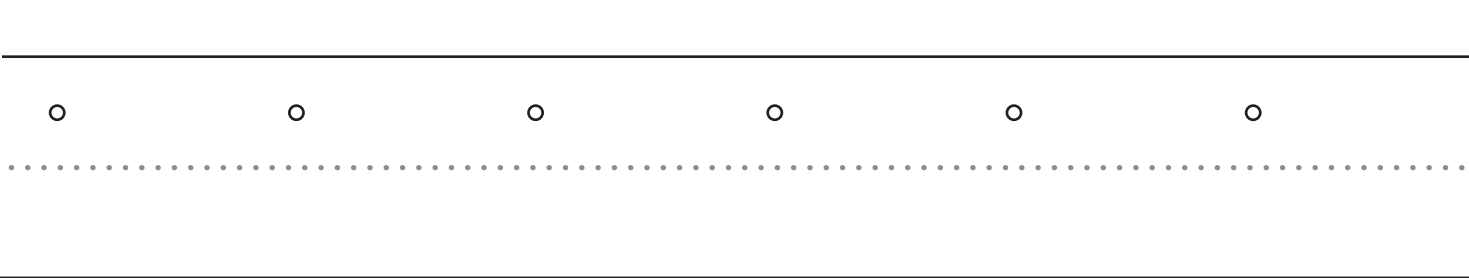
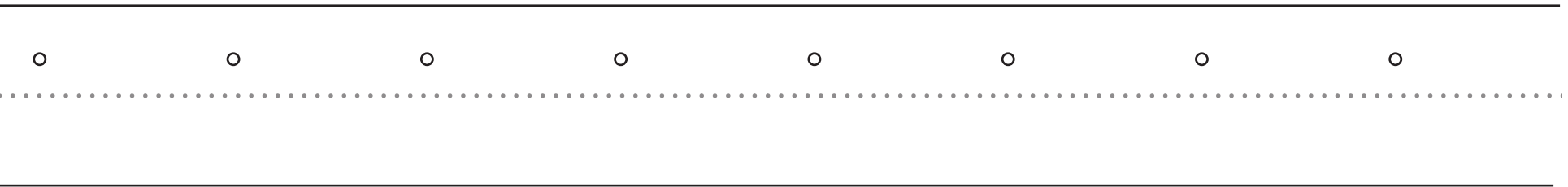
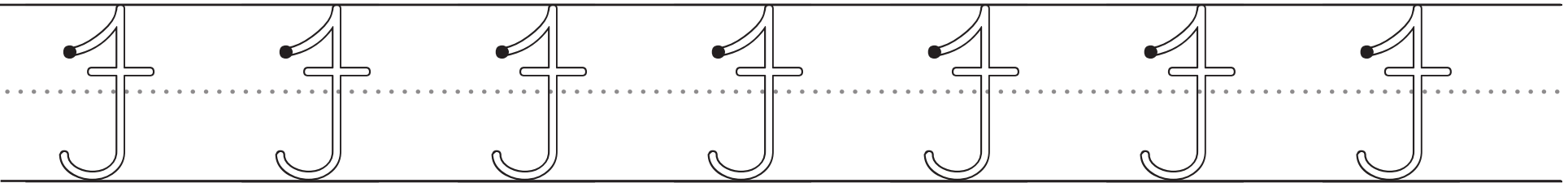
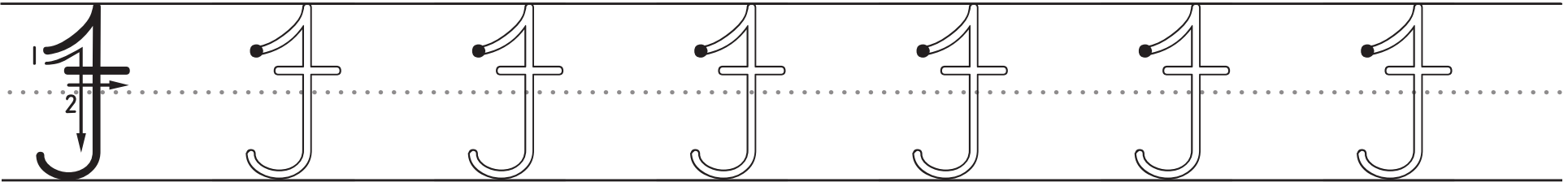

teacher check: _____

cursive F:

G is J

Name: _____

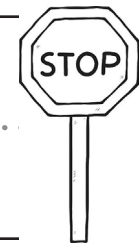
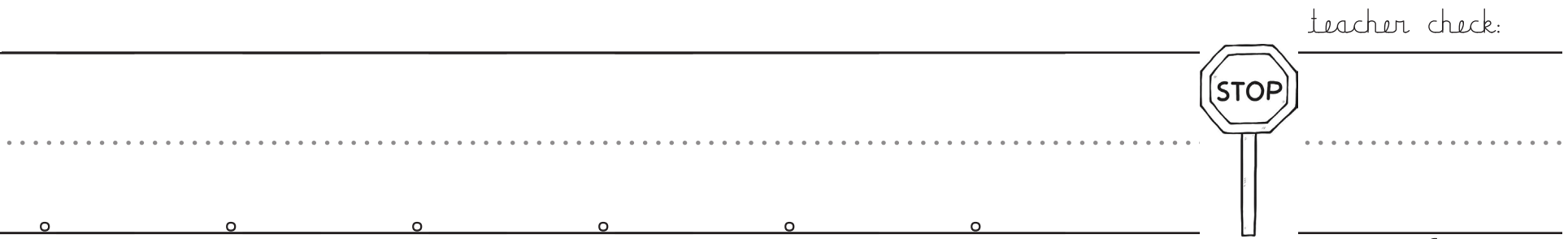
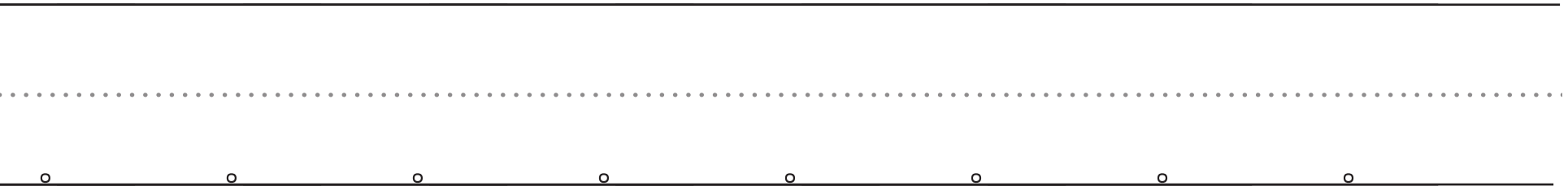
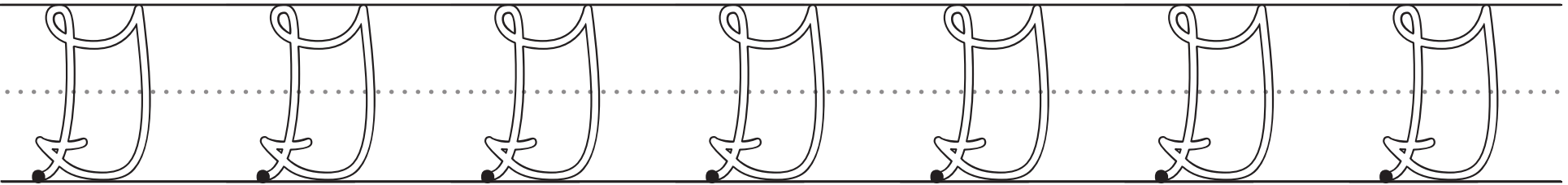
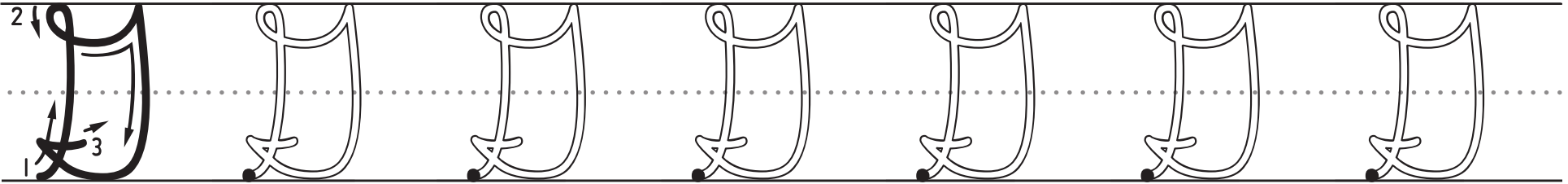

teacher check: _____

cursive G:

H i s H

Name: _____

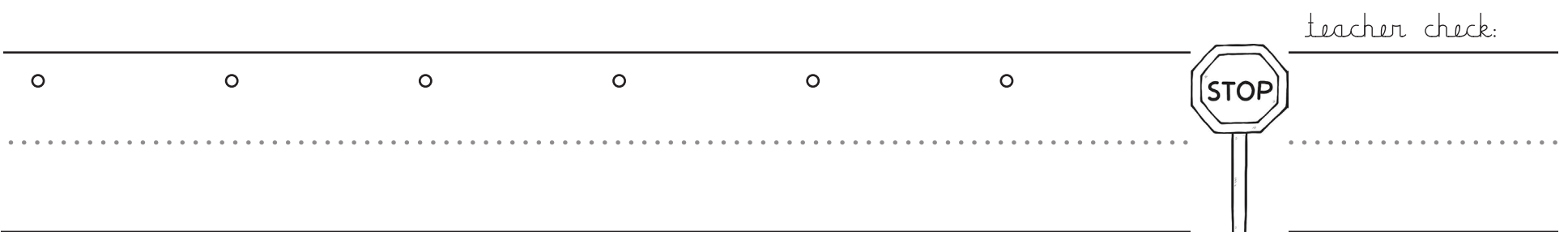
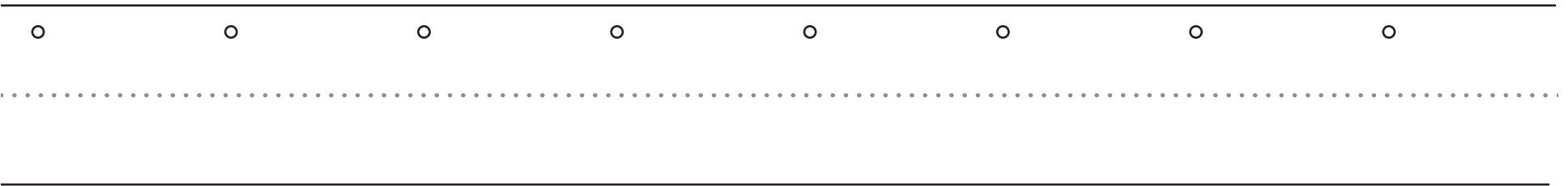
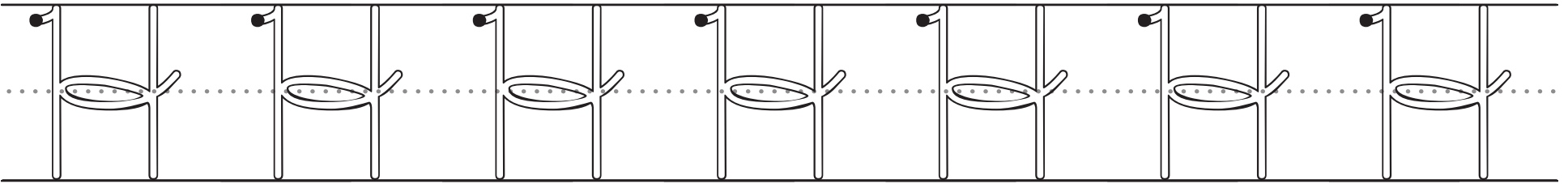
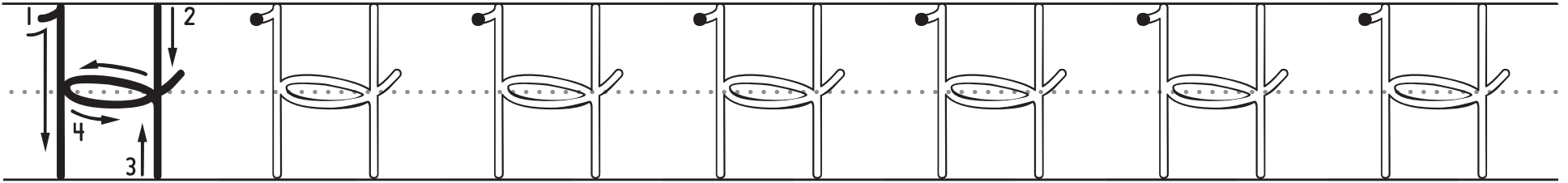

teacher check: _____



I i s l

Name: _____

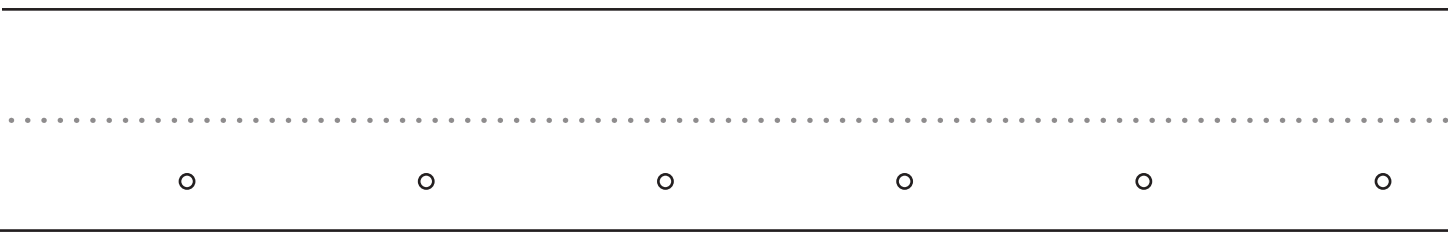
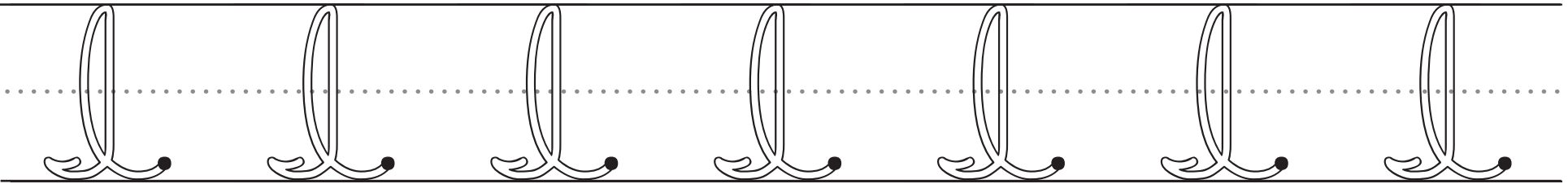
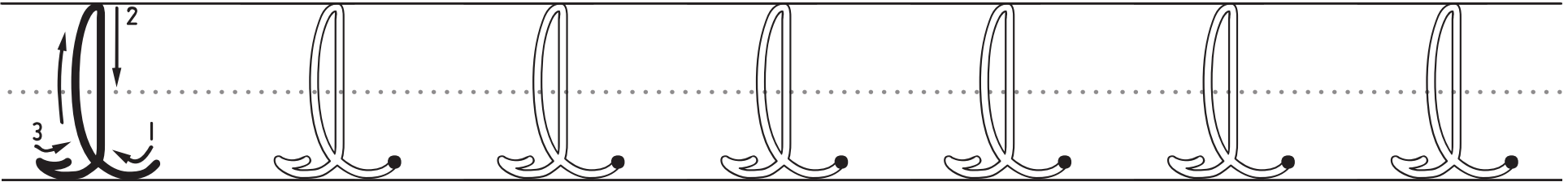

teacher check: _____

cursive I:

J i s q

Name: _____

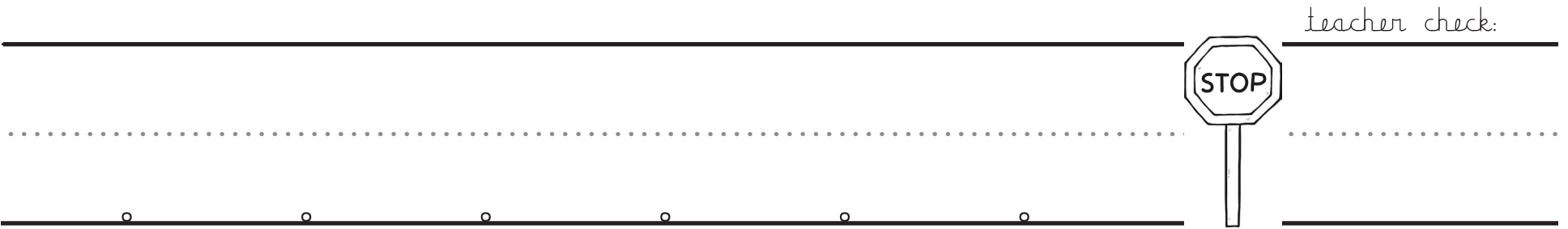
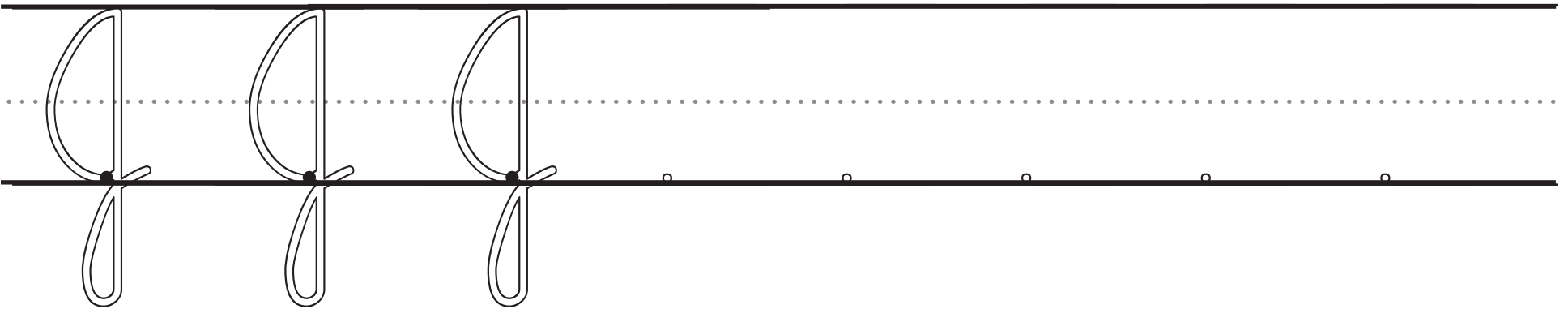
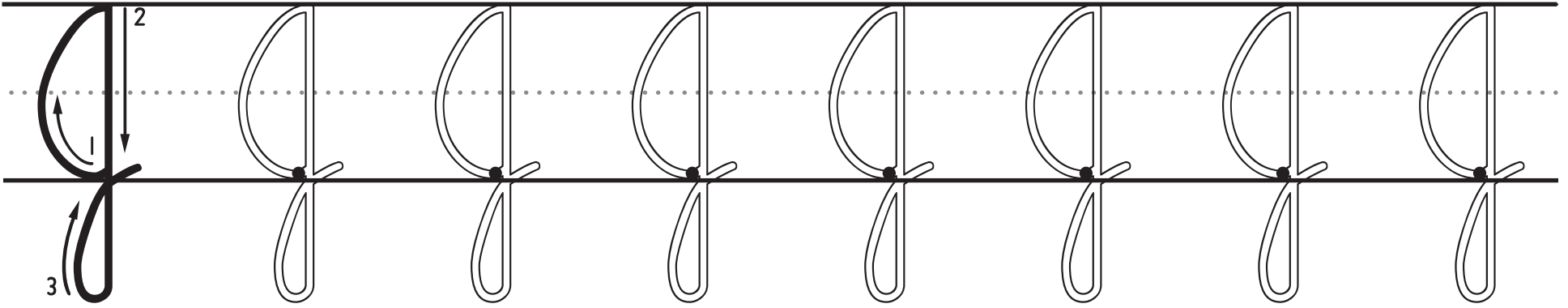

teacher check: _____



cursive J:

K is K

Name: _____

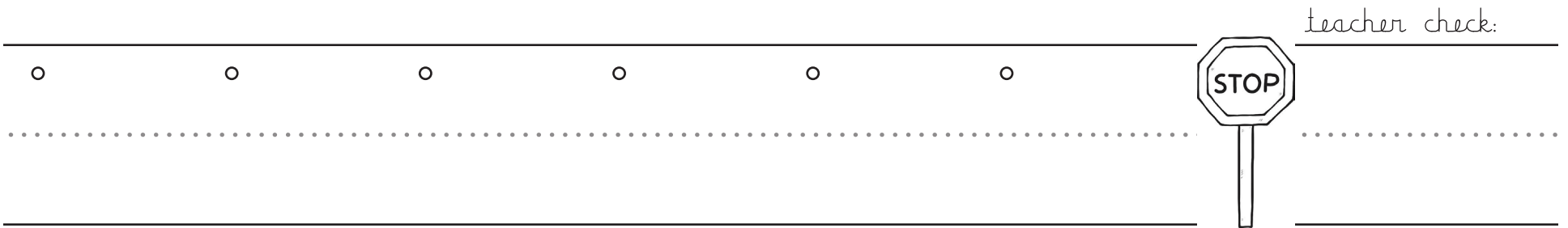
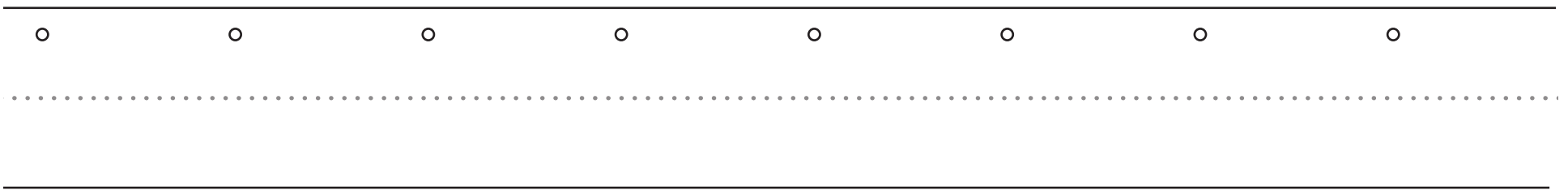
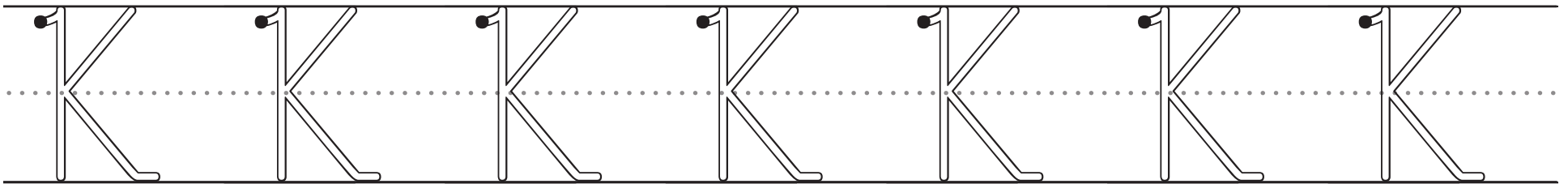
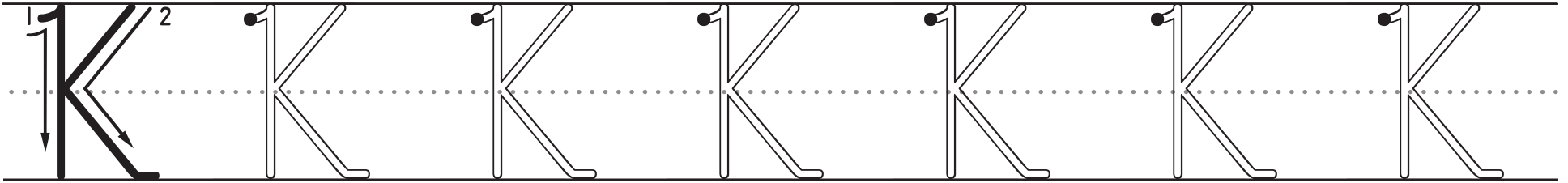

L is L

Name: _____

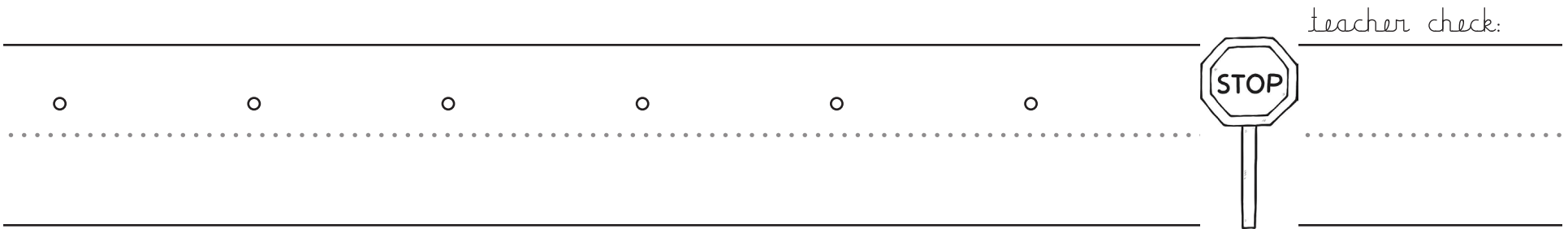
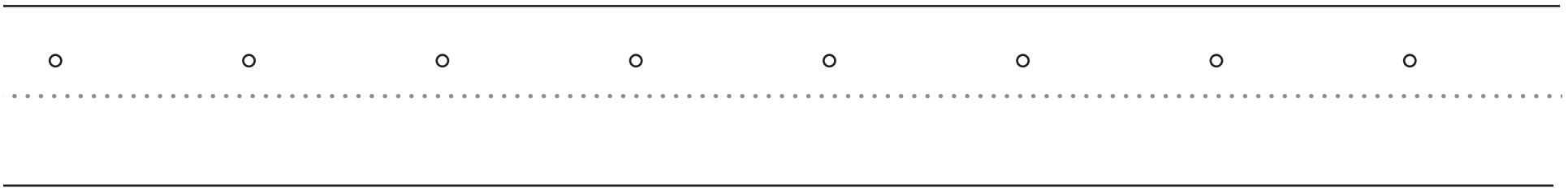
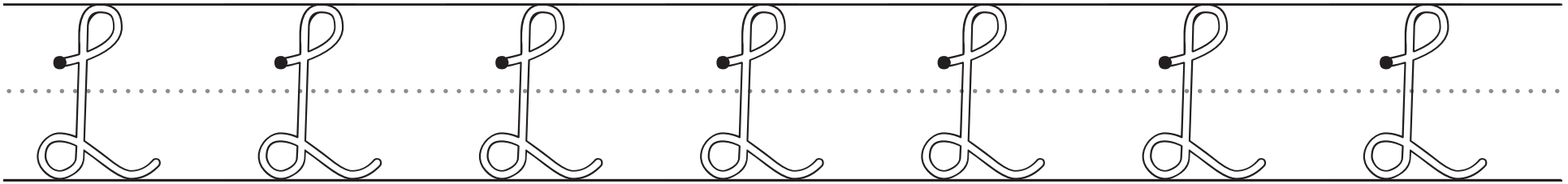
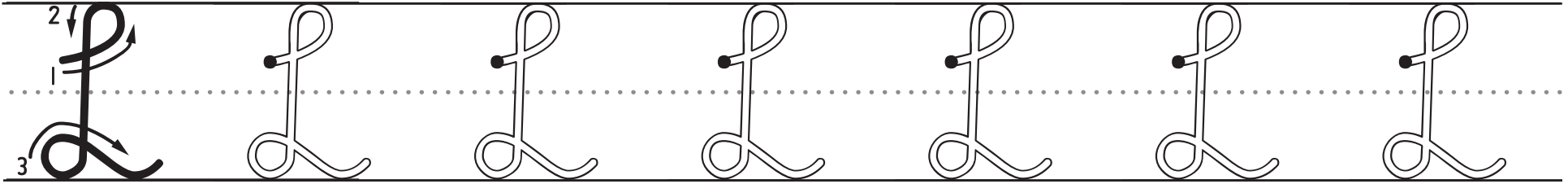

teacher check: _____



cursive L:

M i s m

Name: _____

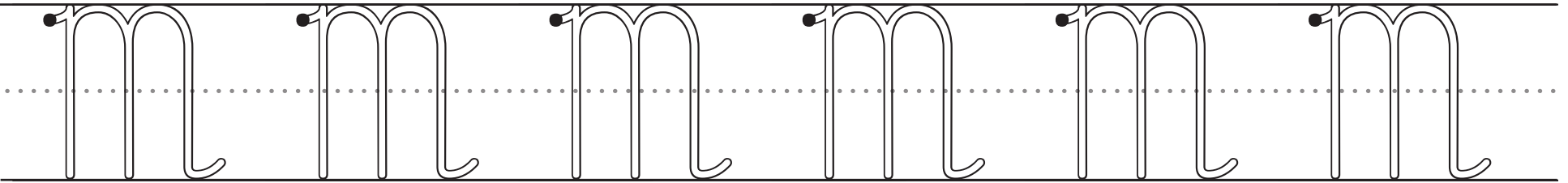
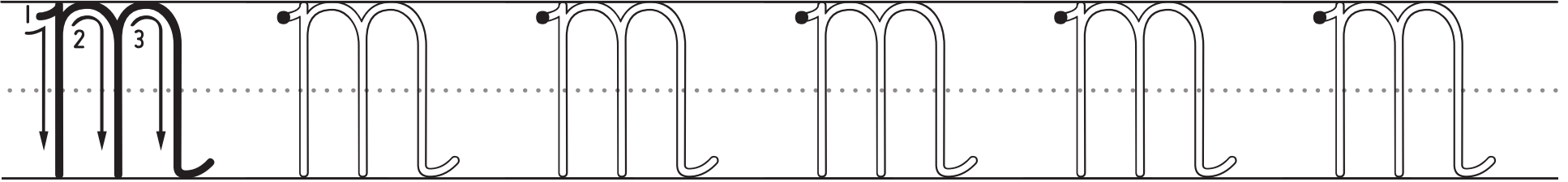

teacher check: _____

cursive M:

N is n

Name: _____

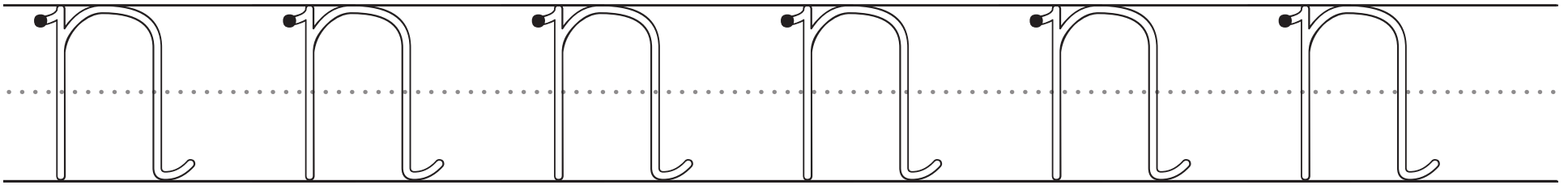
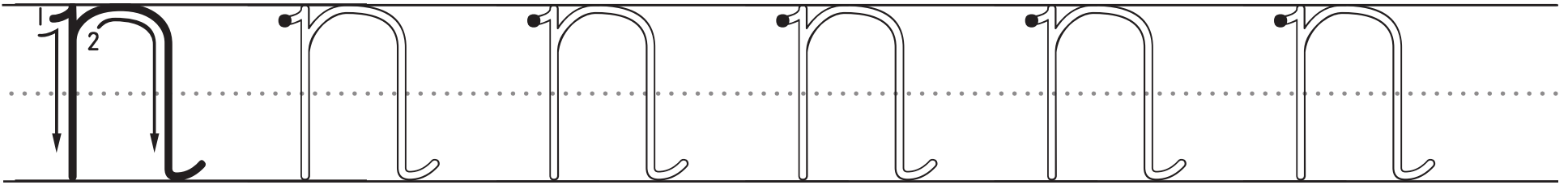

teacher check: _____



cursive N:

O is O

Name: _____

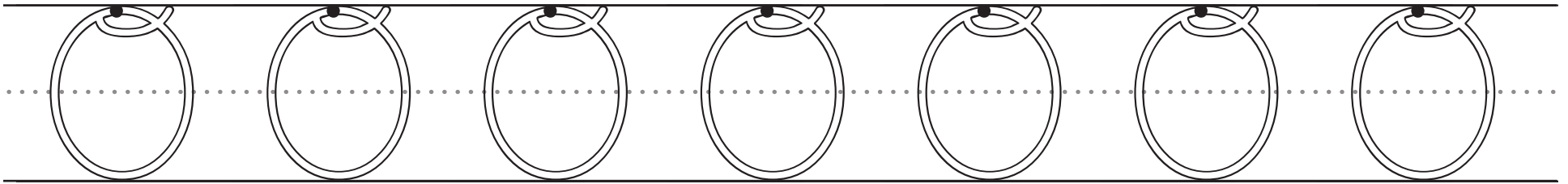
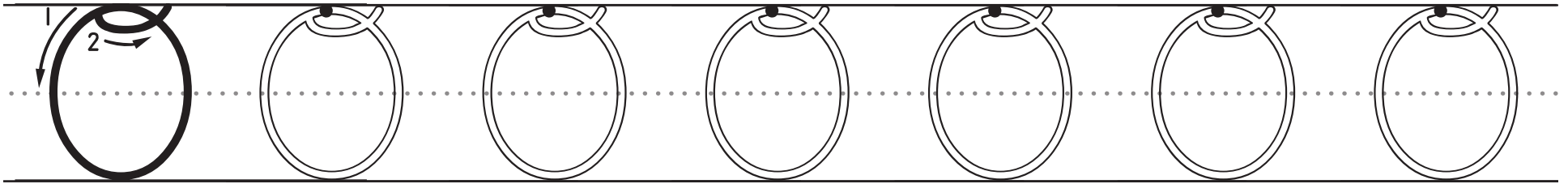

teacher check: _____

cursive O:

P is P

Name: _____

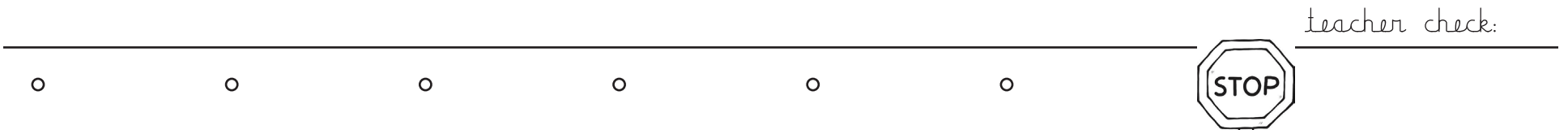
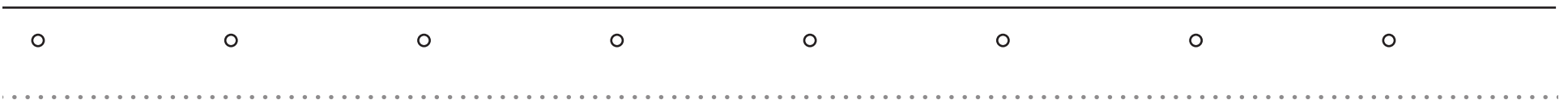
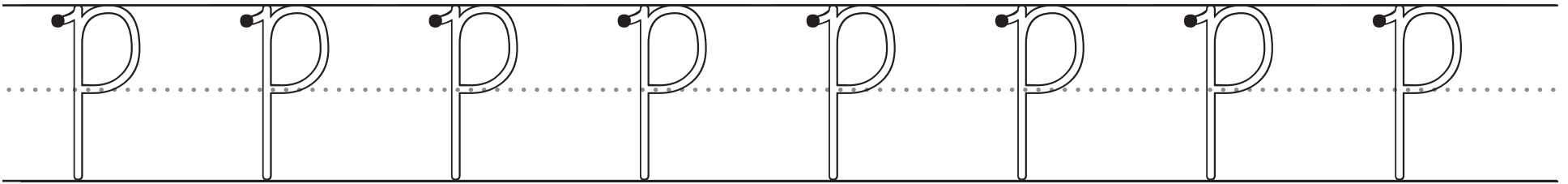
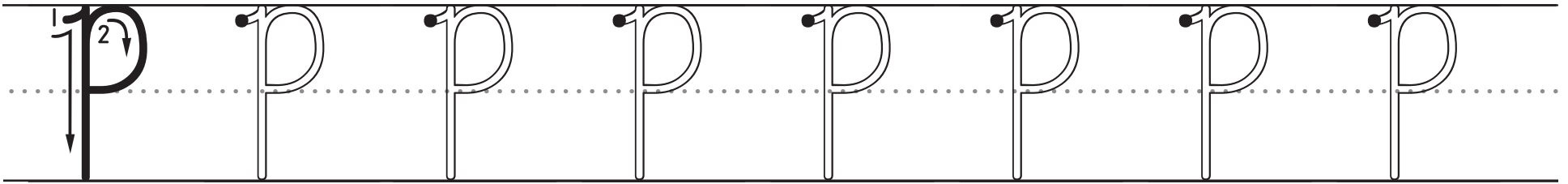

teacher check: _____

cursive P:

Q is 2

Name: _____

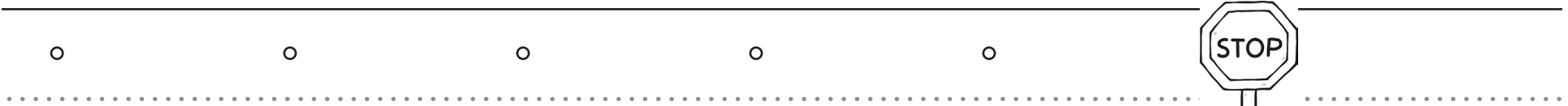
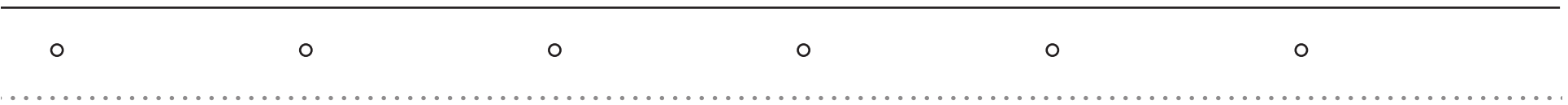
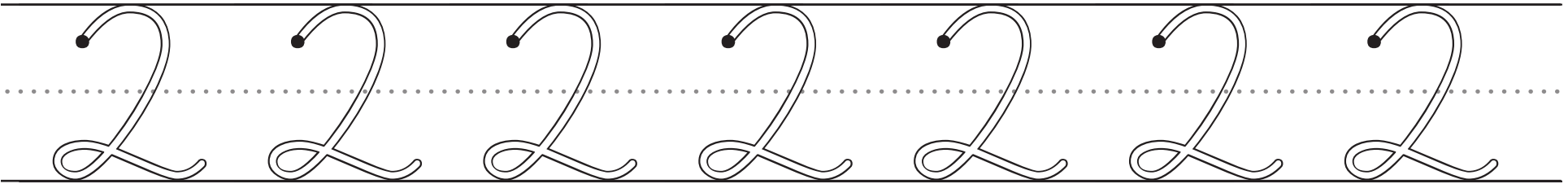
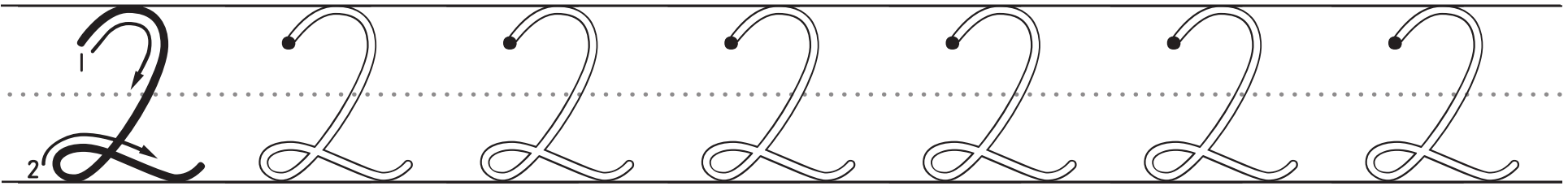

teacher check: _____

cursive Q:

R is R

Name: _____

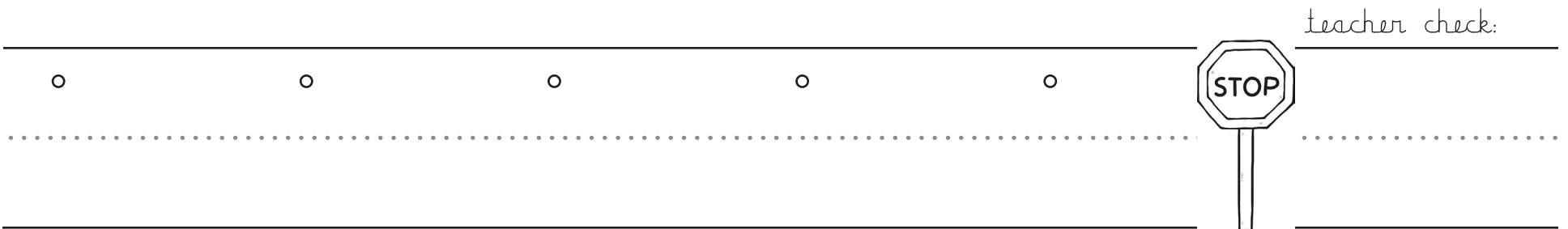
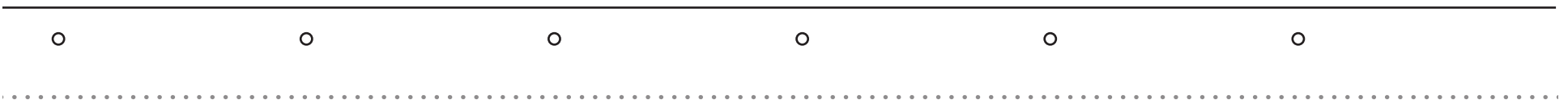
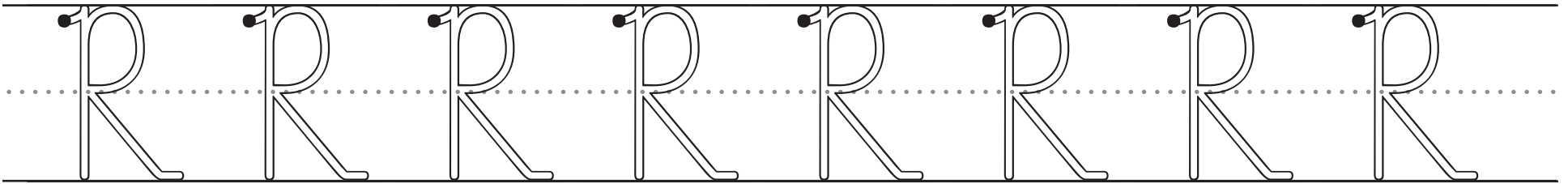
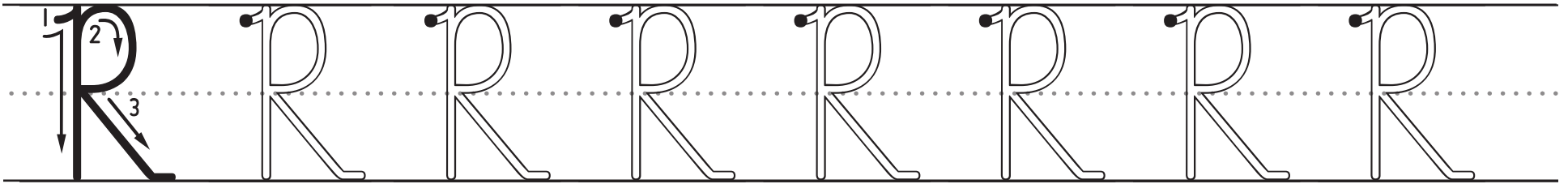

teacher check: _____

cursive R:

S is S

Name: _____

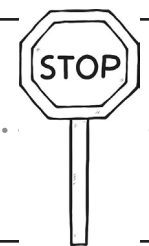
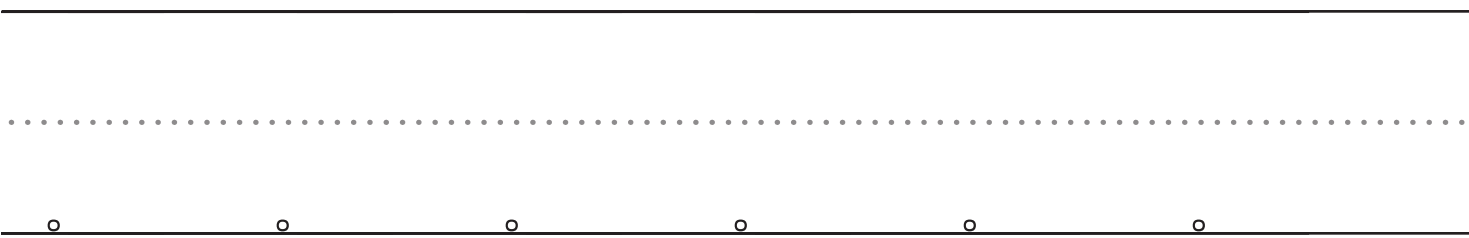
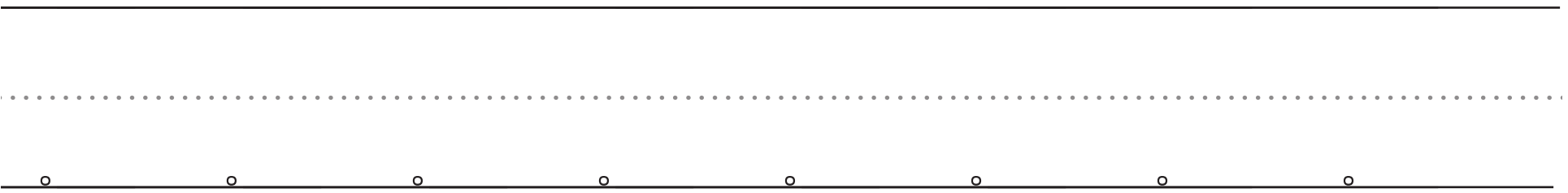
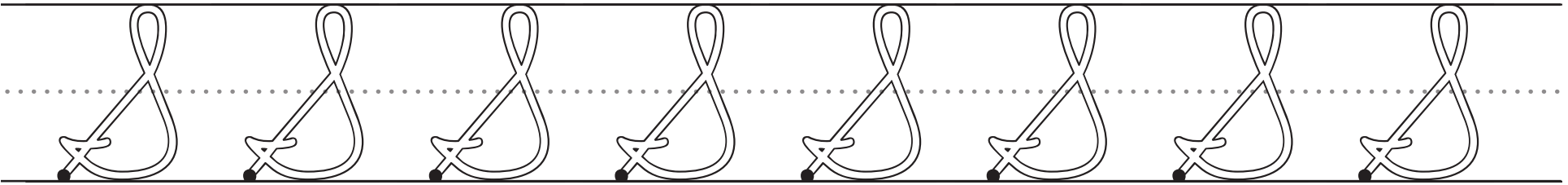
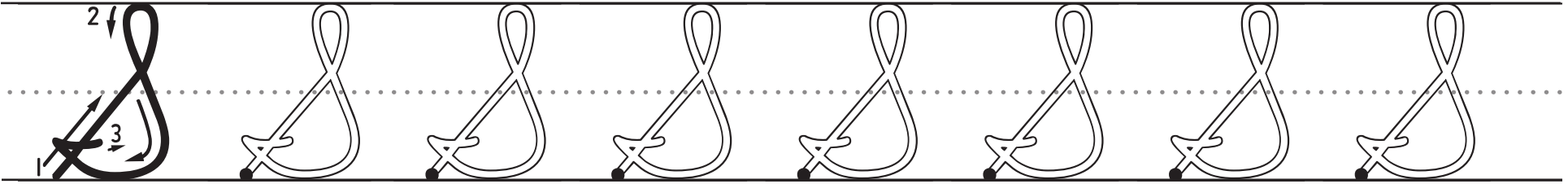

teacher check: _____

cursive S:

T is 1

Name: _____

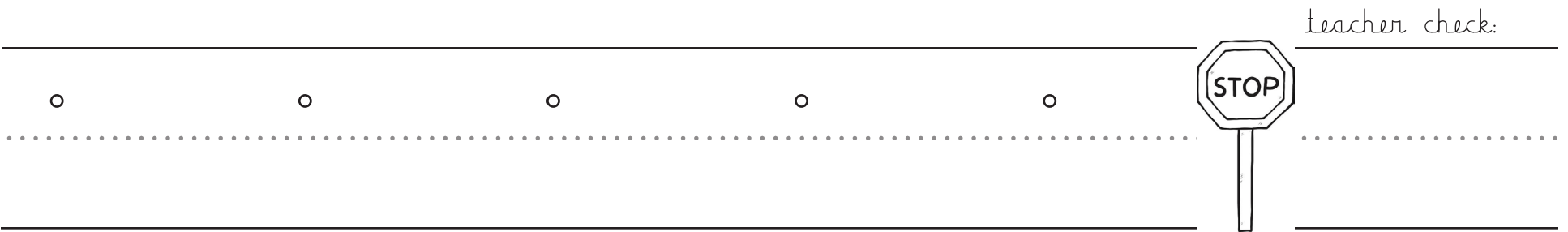
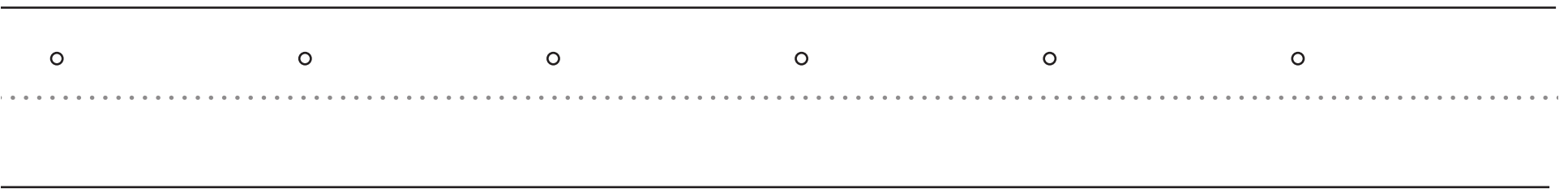
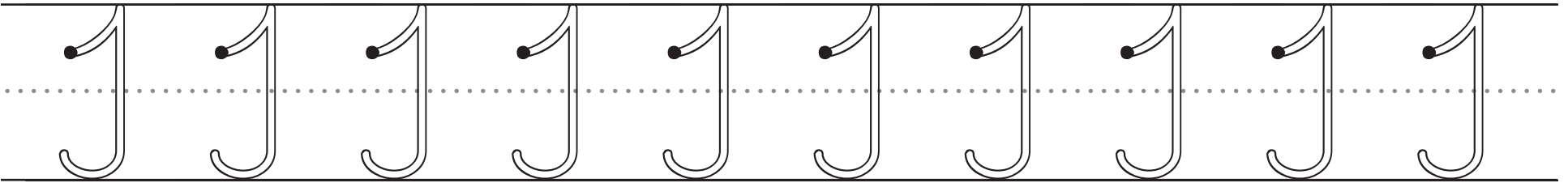
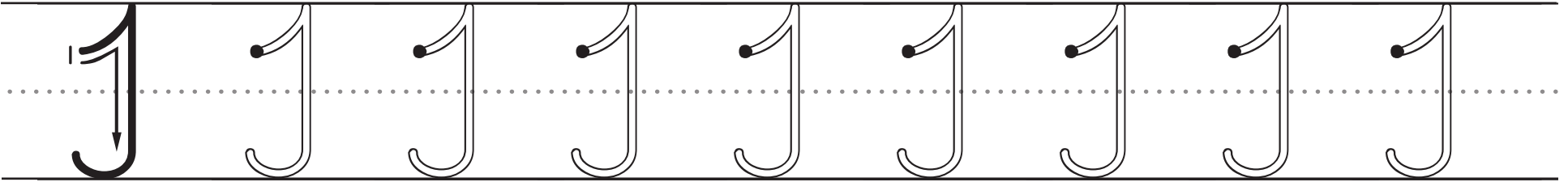

teacher check: _____

cursive T:

U is U

Name: _____

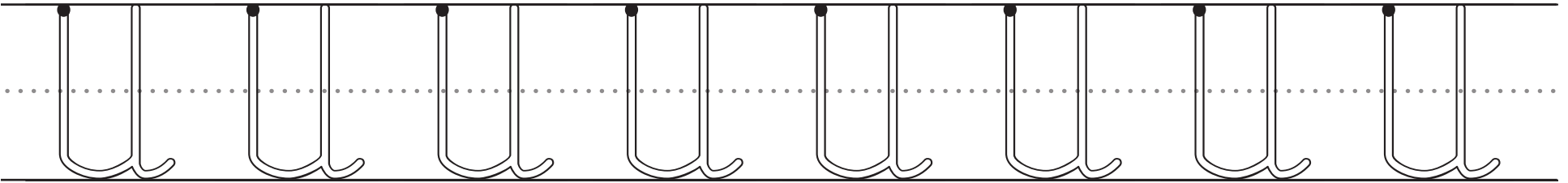
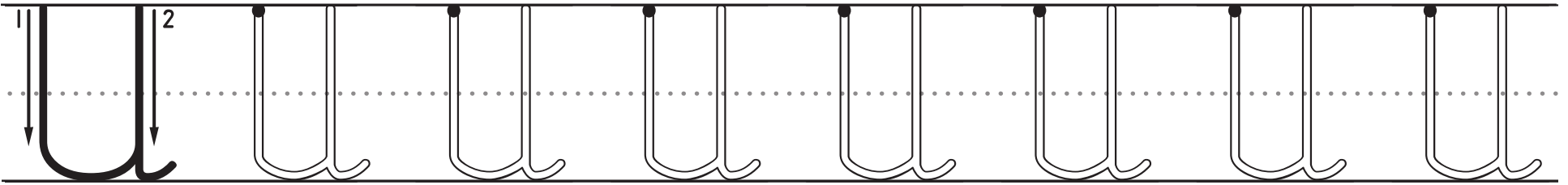

teacher check: _____

cursive U:

V is V

Name: _____

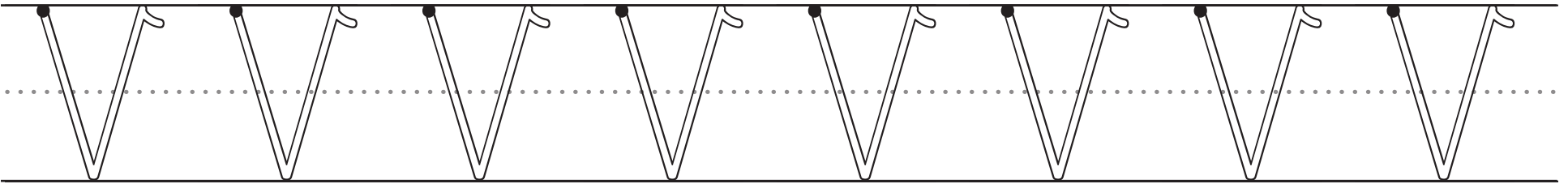
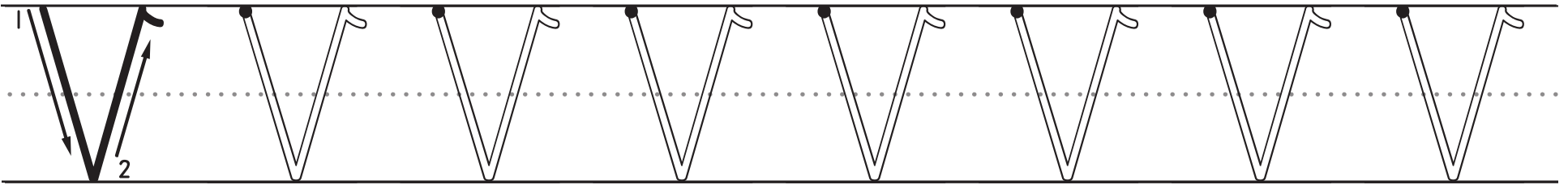

teacher check: _____

cursive V:

W is W

Name: _____

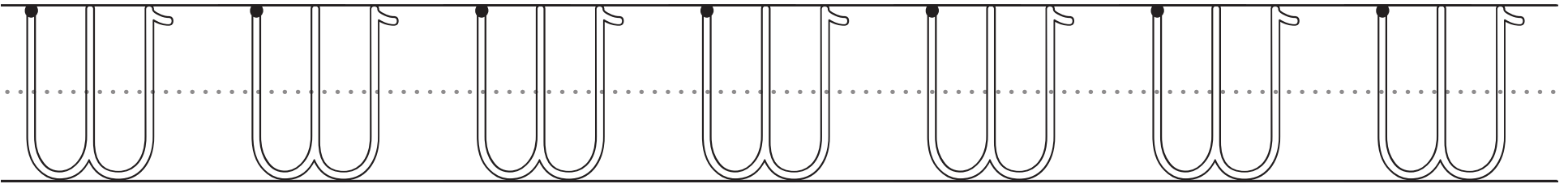
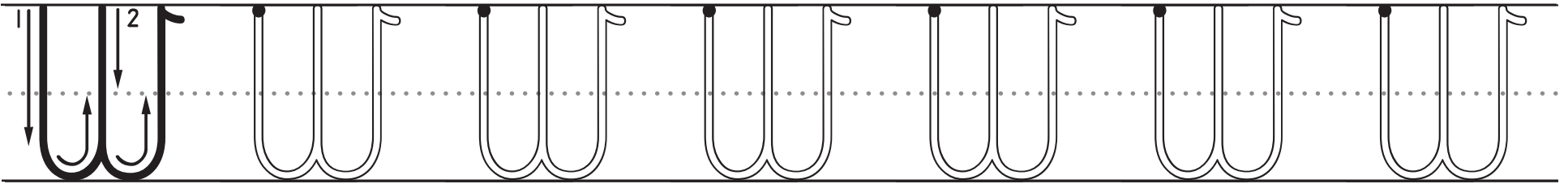

teacher check: _____

cursive W:

X is X

Name: _____

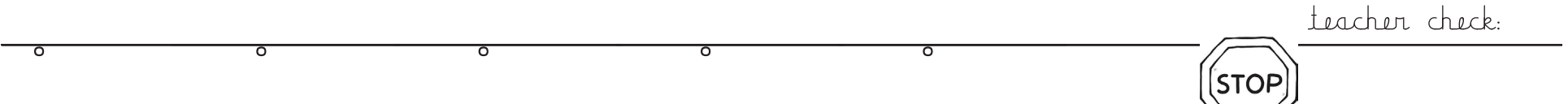
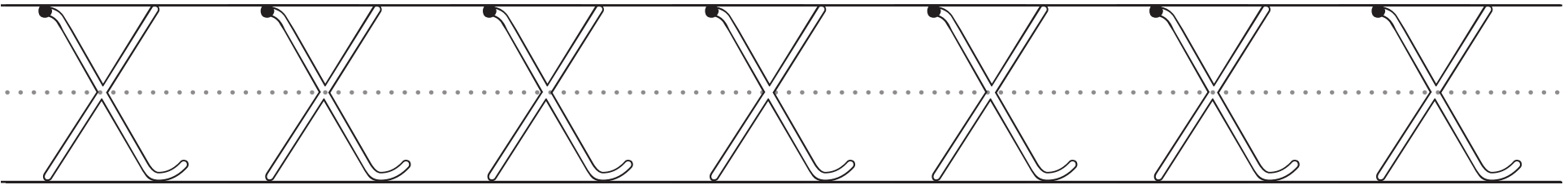
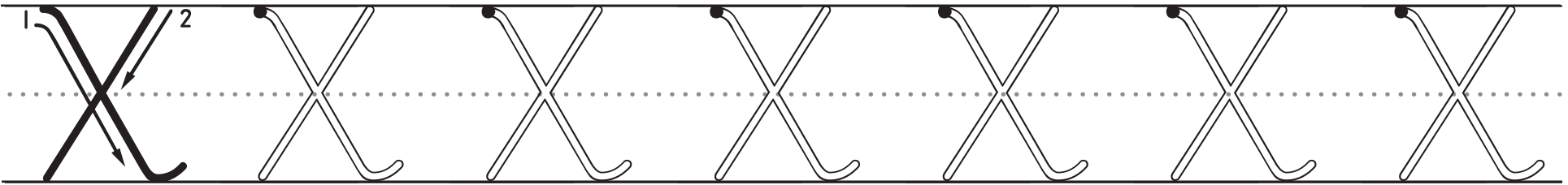

teacher check: _____

cursive X:

Y is y

Name: _____

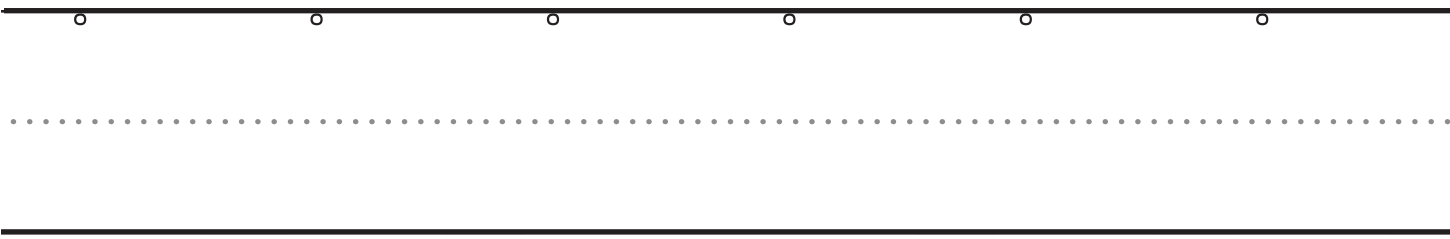
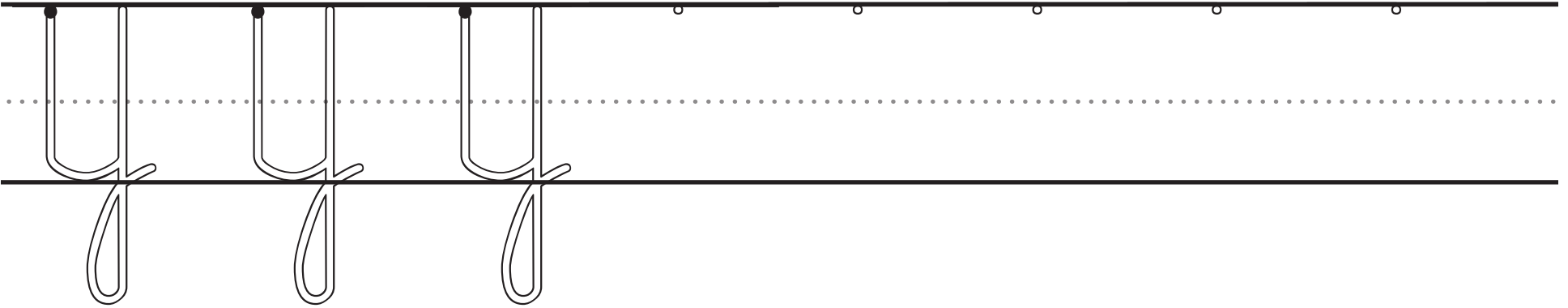
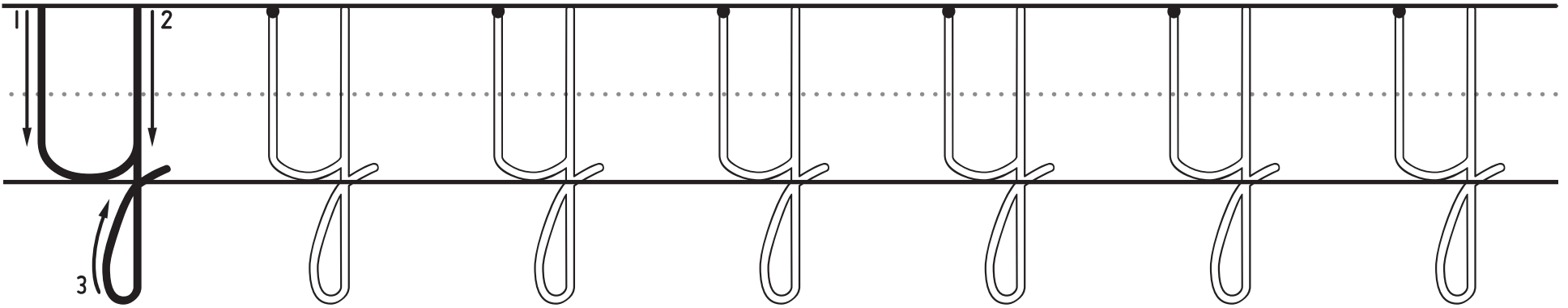

teacher check: _____

cursive Y:

Z is z

Name: _____

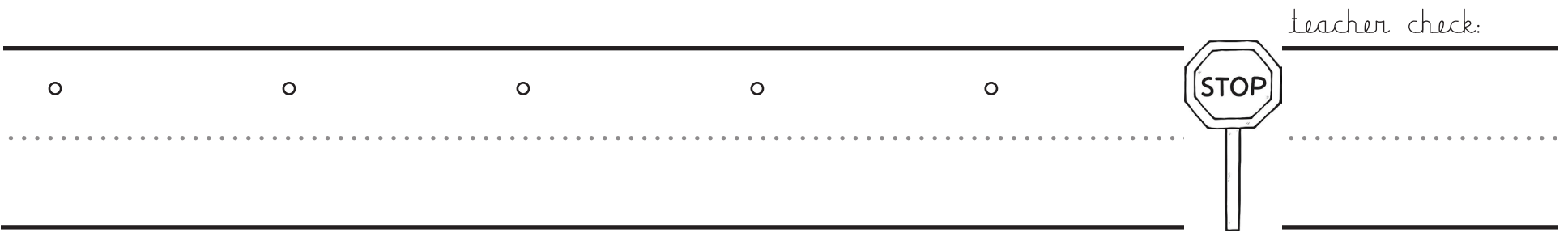
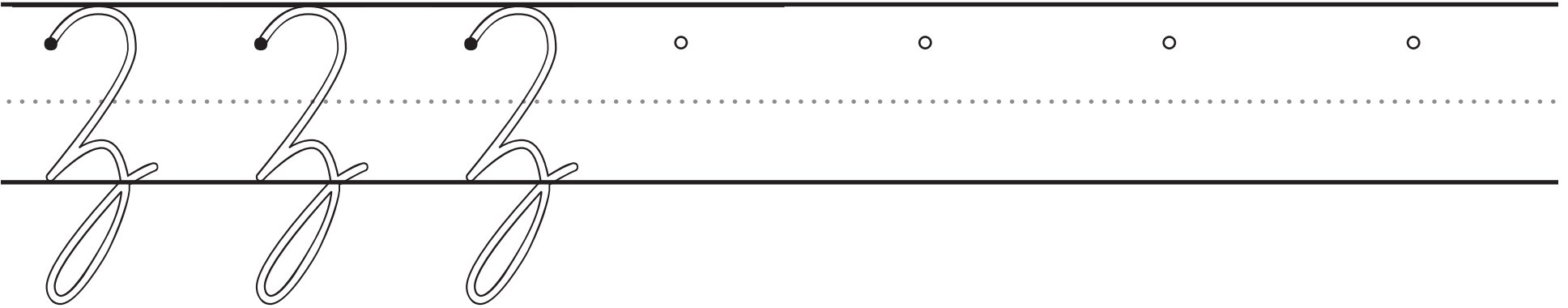
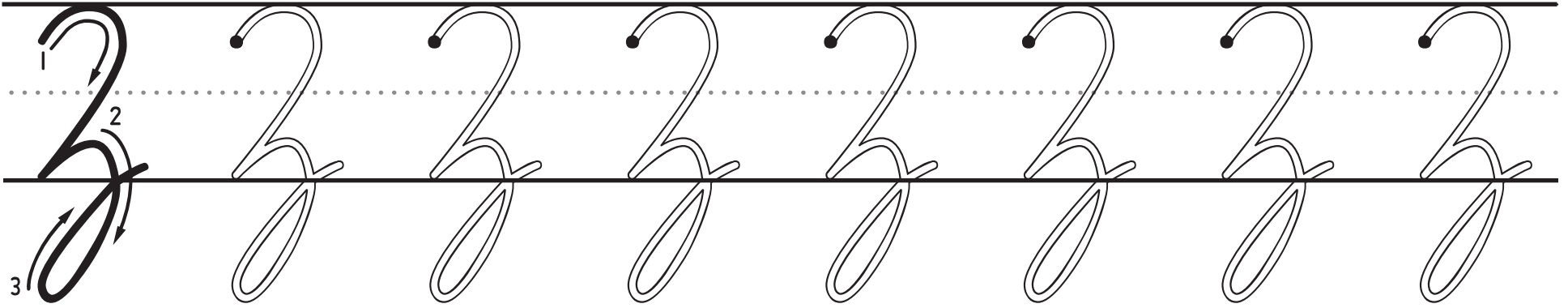

teacher check: _____

cursive Z: